



















## Signatur forklaring til Installationsvejledninger

-  **Passtykke**
-  **Måler**
-  **Snavssamler**
-  **Trykdifferens**
-  **Manometer**
-  **Bundhaner**
-  **Radiator termostat**
-  **Kuglehane**
-  **Gulvvarmefordeler**
-  **Termostat ventil m/fjernføler** (Rav/ Ravk)
-  **Sikkerheds ventil**
-  **Termometer**
-  **Returventil ( som FJVR )**
-  **Trykekspansion**
-  **Kontra ventil**
-  **Pumpe**



## Direkte anlæg med beholder

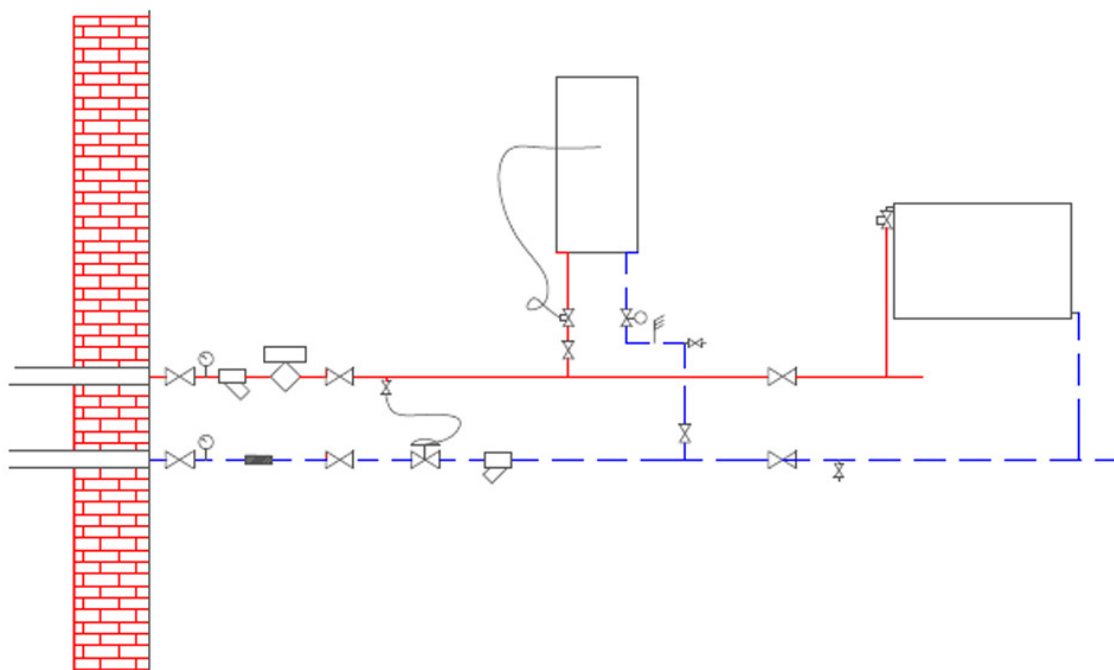

## Indirekte anlæg med beholder, gulvvarme og vejrkompensering

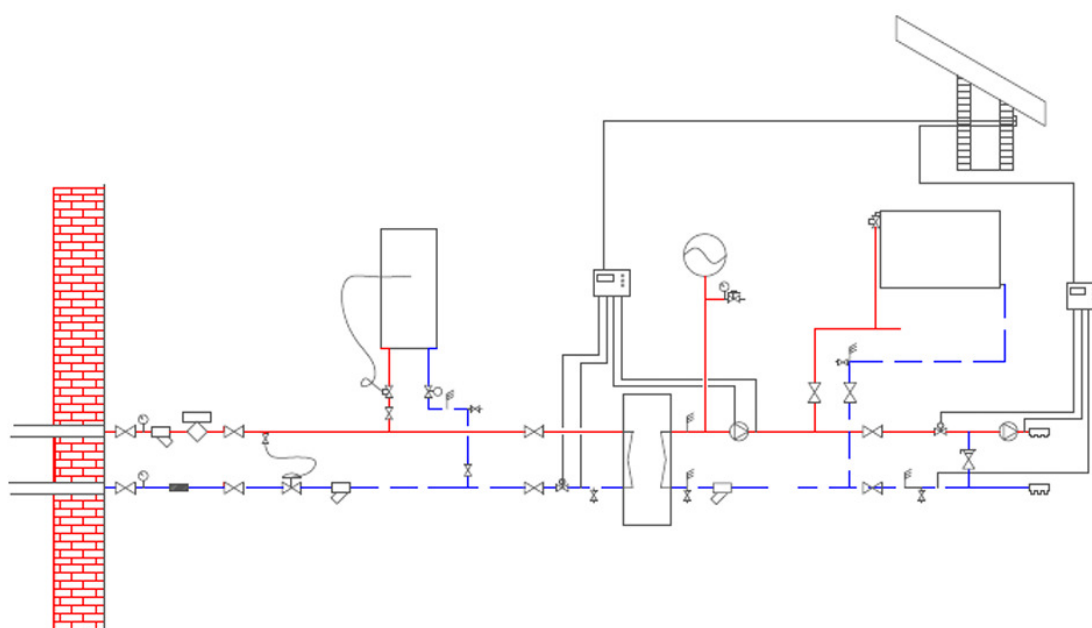



# Direkte anlæg med beholder, gulvvarme og vejrkompensering

